

SUPER TWO[®]

Supervised Alarm/Relay Expansion Unit
With Battery-Backed Accessory Power

Model CICP1300IOCOMBO

Installation and Service Manual

Continental Access



CONTINENTAL INSTRUMENTS LLC

A NAPCO SECURITY GROUP COMPANY

355 Bayview Avenue, Amityville, NY 11701
Phone: 631-842-9400 Fax: 631-842-9135

FCC Warning

Changes or modifications to this unit not expressly approved by the party responsible for compliance could void the user's authority to operate the equipment.

NOTE

This equipment has been tested and found to comply with the limits for a Class A digital device, pursuant to Part 15 of the FCC Rules. These limits are designed to provide reasonable protection against harmful interference when the equipment is operated in a commercial environment. This equipment generates, uses, and can radiate radio frequency energy and, if not installed and used in accordance with the instruction manual, may cause harmful interference to radio communications. Operation of this equipment in a residential area is likely to cause harmful interference in which the user will be required to correct the interference at his own expense.

Shielded cables must be used with this unit to ensure compliance with the Class A FCC limits.

DISCLAIMER

Continental Instruments LLC makes no representations or warranties with respect to the contents hereof and specifically disclaims any implied warranties of merchantability or fitness for any particular purpose. Further, Continental Instruments LLC reserves the right to revise this publication and to make changes from time to time in the content hereof without obligation of Continental Instruments LLC to notify any person of such revision or changes.

Information furnished by Continental Instruments LLC is believed to be accurate and reliable. However, no responsibility is assumed by Continental Instruments LLC for its use; nor for any infringements of other rights of third parties which may result from its use. No license is granted by implications or otherwise under any patent or patent rights of Continental Instruments LLC.

Copyright © 2005 by Continental Instruments LLC. All rights reserved. No part of this publication may be reproduced, transmitted, transcribed, or stored in a retrieval system, without the prior written permission of Continental Instruments LLC, 355 Bayview Avenue, Amityville, NY 11701. 631-842-9400

A NAPCO SECURITY GROUP COMPANY

THE INSTALLATION OF THIS PRODUCT SHOULD BE MADE BY QUALIFIED SERVICE PERSONNEL AND SHOULD CONFORM TO ALL LOCAL CODES.



	 <p>The lightning flash with arrowhead symbol, within an equilateral triangle, is intended to alert the user to the presence of uninsulated 'dangerous voltage' within the product's enclosure that may be of sufficient magnitude to constitute a risk of electric shock to persons.</p>  <p>The exclamation point within an equilateral triangle is intended to alert the user to the presence of important operating and maintenance (servicing) instructions in the literature accompanying the product.</p>
<p style="text-align: center;">WARNING</p> <p>This product generates, uses, and can radiate radio frequency energy and if not installed and used in accordance with the instruction manual, may cause interference to radio communications. It has been tested and found to comply with the limits for a Class A computing device pursuant to Part 15 of FCC Rules, which are designed to provide reasonable protection against such interference when operated in a commercial environment. Operation of this product in a residential area is likely to cause interference in which case the user at his own expense will be required to take whatever measures may be required to correct the interference.</p>	<p style="text-align: center;">UNPACKING AND INSPECTION</p> <p>Unpack carefully. This is an electronic product and should be handled as such. Compare the items received with the packing list with your order.</p> <p>BE SURE TO SAVE THE SHIPPING CARTONS AND INSERT PIECES. THEY ARE THE SAFEST MATERIAL IN WHICH TO MAKE FUTURE SHIPMENTS OF THE PRODUCT.</p>
<p style="text-align: center;">WARNING</p> <p>TO REDUCE THE RISK OF FIRE OR SHOCK HAZARD, DO NOT EXPOSE THIS PRODUCT TO RAIN OR MOISTURE.</p>	<p style="text-align: center;">MAINTENANCE</p> <p>User maintenance of this unit is limited to external cleaning and inspection.</p>

TABLE OF CONTENTS

DESCRIPTION	5
IMPORTANT SAFETY INFORMATION	6
CONFIGURATION	7
<i>PC Board Layout: Alarm/Relay Board</i>	8
<i>PC Board Layout: Charger Board in</i>	9
<i>Additional Configurations</i>	10
INSTALLATION	11
<i>Installation Preparation</i>	12
<i>Cabinet Mounting</i>	13
<i>Cable and Wiring Categories</i>	14
<i>Mains Power Cables and Wiring</i>	14
<i>Low-Voltage Power and Accessory Relay Devices</i>	14
<i>Communication Cables</i>	14
<i>Incoming Power Conduit Knockout</i>	14
<i>Accessory Conduit Knockouts</i>	14
<i>Grounding Accessory Drain and Shield Wires</i>	14
POWER CONNECTIONS	15
<i>AC Power Source Grounding</i>	15
<i>Modular Cable</i>	16
ACCESSORY POWER	17
RELAY POWER	17
RELAY CONNECTIONS	18
<i>Relay Characteristics</i>	18
ALARM CONNECTION	
<i>Supervised Alarms</i>	19
<i>Configuring an Alarm in the Supervised Condition</i>	19
<i>Alarm Cable Requirements</i>	19
<i>Tamper Switch</i>	19
CIRCUIT PROTECTION	20
<i>Expansion Unit Primary Fuse</i>	20
<i>Expansion Unit Power Supply Fuse</i>	21
<i>Expansion Unit Accessory Circuit Protection</i>	21
INTERNAL EXPANSION	22
<i>Installing the Second Supervised Alarm/Relay Board</i>	22
MAINTENANCE	23
<i>Power Supply Replacement</i>	23
<i>Backup Battery Replacement</i>	23
SPECIFICATIONS	24
POWER RATINGS	24
APPENDIX A	25
WARRANTY	26
INDEX	28

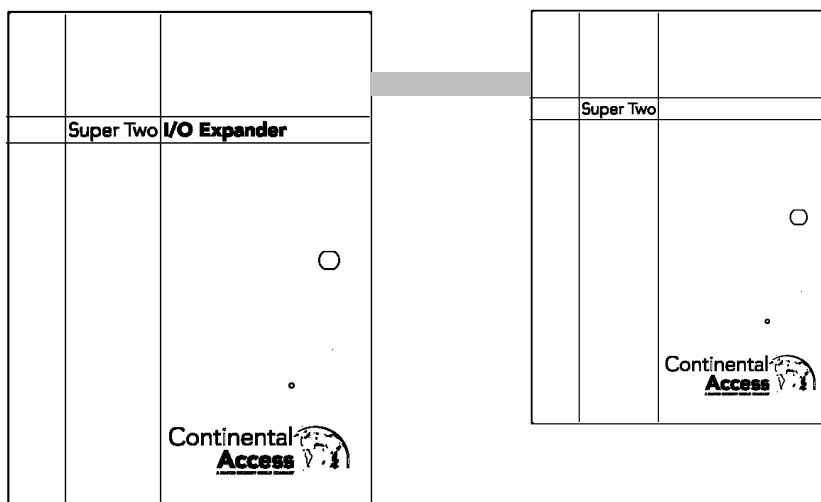

DESCRIPTION

The CICP1300IOCOMBO comes configured in one enclosure with one Supervised Alarm / Relay Board, one “Universal Input” power supply, and one 7AH backup battery with a Battery-Top Charger.

The following is provided on a single main PCB:

- Sixteen supervised inputs with performance matching that of the ALARM inputs of the Super Two. A status change is signaled by a half-second activation of an EVENT lamp.
- Sixteen relay outputs with LED indication of relay activation.
- An OK lamp that blinks to indicate correct operation of the equipment.
- Status lamps show LOGIC power and 12V relay power.

Sixteen more alarm inputs and sixteen more relays may be added into the enclosure by ordering and installing a second CICP1300IOBD Supervised Alarm / Relay Board.

As with the original Superterm expansion boards, using three boards, a total of 48 supervised inputs and 48 relays are added. Each Super Two Access Control panel may be configured to monitor a total of 56 supervised alarm inputs, and may control a total of 52 relay outputs. The three-board configuration will require an additional enclosure.

The power supply, battery and battery charger are installed in the lower part of the enclosure. These provide a battery-backed 12Vdc at 1.6A. The charger PCB provides open-collector outputs to signal AC failure and 12V failure signals which may be connected to the Alarm Inputs or the Accessory Alarm Inputs of the Super Two. After an AC power failure, the 7AH battery can be expected to carry a 1.6 Amp load for approximately four hours. The Alarm Monitoring functions of the Alarm/Relay Board are powered by the Access Control Panel and continue as long as the Access Control Panel is active.

The Expansion Enclosure offers a matching appearance to the Super Two. A tamper switch is installed which may be monitored by an accessory alarm input of the Super Two or by one of the inputs on the Supervised Alarm / Relay Board.

The enclosure is the same width as the Super Two housing, but 3” taller to contain the power supply and battery, and to allow a channel for field wiring across the top inside the unit.

The Access Control Panel and the Alarm/Relay Expansion Unit(s) are connected and powered by short modular [RJ12] cables provided. These cables must be routed through short pieces of metal conduit. When powered from the main unit, the 12 volt relay power wiring may also be routed through this conduit.

A three-foot RJ12 cable is provided with each Expansion Enclosure Unit, and a four-inch RJ12 cable is provided with each Alarm/Relay Expansion Board.

Host Software Version 2.3.16 build 166 or later is required to operate with the Supervise Alarm / Relay Expansion Board. Firmware release 2.0.15 or later must be installed or downloaded to the Access Control Panel.

The Expansion Power Supply supplied with the CICP1300IOCOMBO automatically switches from 120 VAC/60Hz to 230 VAC/50Hz to meet the requirements of both North American and the European Union. TÜV America examined the performance of the product to the requirements of EN 60 950, applicable to installations in the European Union.

The Battery-Top Charger provides a Fast Charge / Taper Charge to the backup battery. All output circuits are protected by self-resetting fuses and are energy-limited.

IMPORTANT SAFETY INFORMATION

The Super Two is defined as a Stand-Alone Access Control System. The PC connection provides convenient setup and monitoring of the system, but all decision-making for a cardholder's authorizations at a particular time and place are made by the Access Control Panel. Likewise, all time-controlled relay activities and link functions of the Access Control Panel and the Alarm/Relay Expansion Unit do not depend upon the normal operation of the PC. During disruptions in the operation of the PC, or the communications link with the PC, Access Transactions, Alarm Events, and other activities are logged in the individual Access Control Panel. When communication is restored, these buffered transactions are transferred to the PC.

The Expansion Unit is to be installed in a secured area. Nevertheless, because opening the enclosure door gives access to terminals that can allow false signals, a tamper switch is installed on the door. The tamper switch must be configured at the host computer to signal an alert when the tamper switch is an open-circuit. The tamper switch may also be configured to activate the console relay, which may then be wired into a Burglar Alarm Signal Circuit or an Alarm Sounding Circuit.

In some localities, the Alarm Circuit and Relay Circuit wiring may use UL Type CM or UL Type CL2 foil-shielded multi-conductor and multi-pair cable. Where the AHJ's (Authorities Having Jurisdiction) require Plenum-Rated cabling, UL Type CL2P cabling will be acceptable. In Canadian installations, CSA CMG FT4 foil-shielded cabling may be used in non-plenum installations, and CSA CMP FT6 foil-shielded cabling may be used in installations requiring plenum ratings.

The Expansion Unit must be installed on a wall, permanently connected to the AC Mains. To minimize disruptive effects from ground loops, use the same AC branch circuit that powers the Access Control Panel.

Fault-Tolerance, Fault Isolation, and Conditions that may result in impaired operation.

Sensing the status of the Accessory Alarm Inputs will be impaired by a cut cable or short-circuit in the Alarm Signal Circuit wiring. By installing end-of-line termination resistors, as described in this manual, the Alarm Circuits may be supervised to detect such faults and indicate the need for a repair.

The Access Control Panel constantly exchanges data with the Alarm/Relay Expansion Board through the modular cable. If the cable is disconnected while the units are powered, no equipment damage will occur, but setup data stored in the Expansion Board will be lost. When the cable is reconnected, the relays will not be activated. Self-Test Firmware in the Access Control Panel will detect this disruption, and restore the setup data and relay activation within one minute. Resetting the Access Control Panel will immediately restore normal operation of the Expansion Units. The 12 Volt output of the Power Supply is inherently Power-Limited. The Charger Board uses self-resetting current limiting devices in the Accessory Output circuit and the Backup Battery circuit.

CONFIGURATION

CICP1300IOCOMBO Supervised Alarm/Relay Expansion Unit with Battery-Backed Accessory Power

Modular Cable - A three-foot, 6-Pin, 6-Conductor modular cable is provided to supply the data and logic power connection to the Super Two or other compatible Access Control Panel. This must be plugged into the right side of the CICP1300IOBD Board, routed through metal conduit, and plugged into the Modular Jack on the left side of the Super Two Access Control Panel.

Component Layout is shown below.

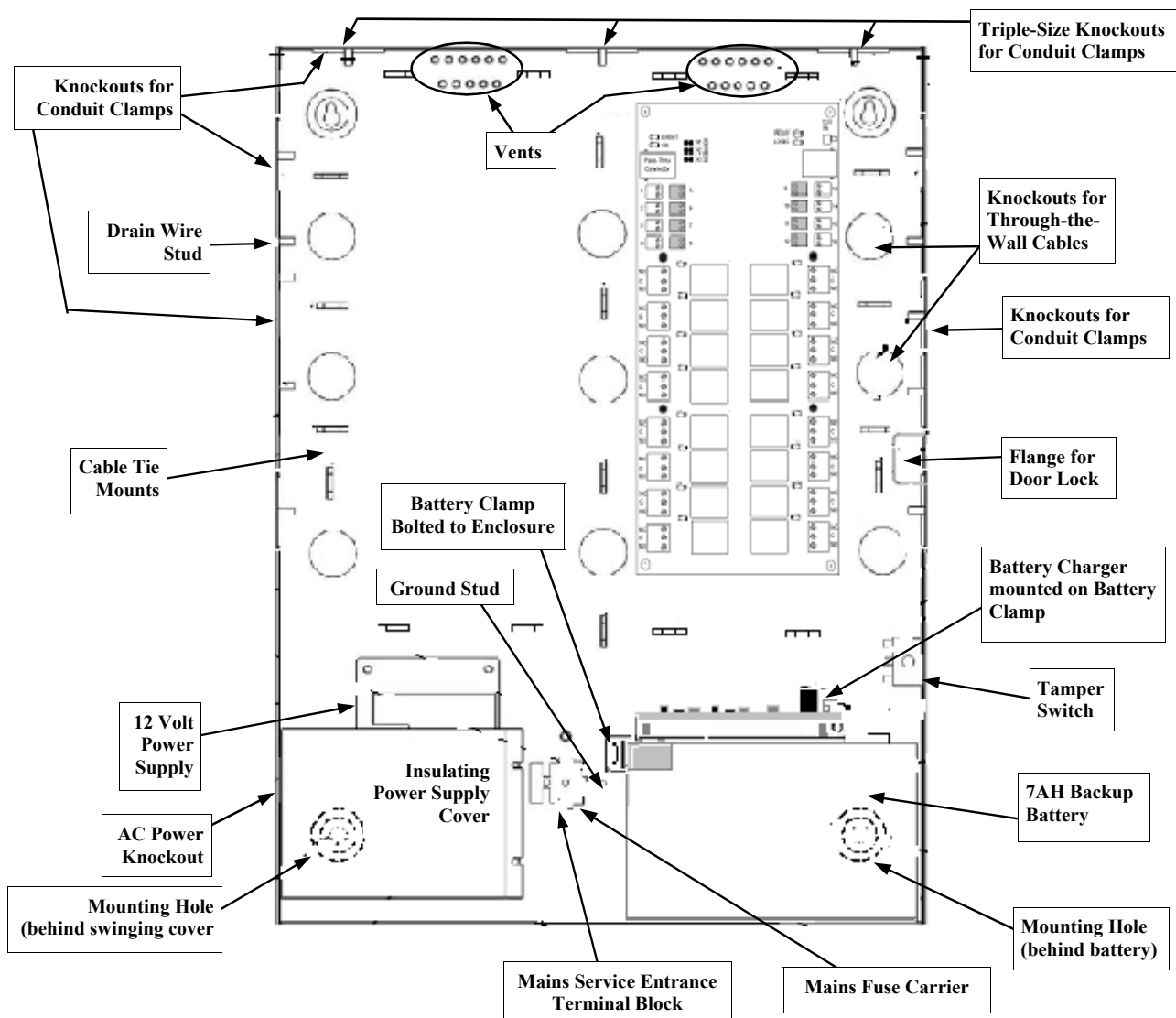

Figure 1 - Expansion Unit Components

CONFIGURATION

PC Board Layout: Alarm/Relay Board (CICP1300IOBD)

INDICATORS

- **EVENT** - Flashes on/off to indicate a change in any Alarm Input status.
- **OK** - Flashes steadily to indicate a working connection to the control panel.
- **RELAY** - Indicates working power connection via 12V IN.
- **LOGIC** - Working 5 volt power from control panel.
- **LEDs near Relays** indicate activation of individual relay.

ADDRESS

A jumper must be set to X1, X2, or X3.
Each Board must be set to a different address.

I/O SERIAL SIGNAL and LOGIC POWER

Connect to control panel or pass-thru connector using the modular cable supplied.

12V IN
Powers the relay coils

SIXTEEN SUPERVISED ALARM INPUTS

May be configured as Normally-Open / Normally Closed; Supervised (requiring termination resistors) or Unsupervised (requiring plain electrical contacts).

RELAY CONTACTS

Normally-Open and Normally-Closed contacts available. Contacts rated 2A 24V AC/DC.

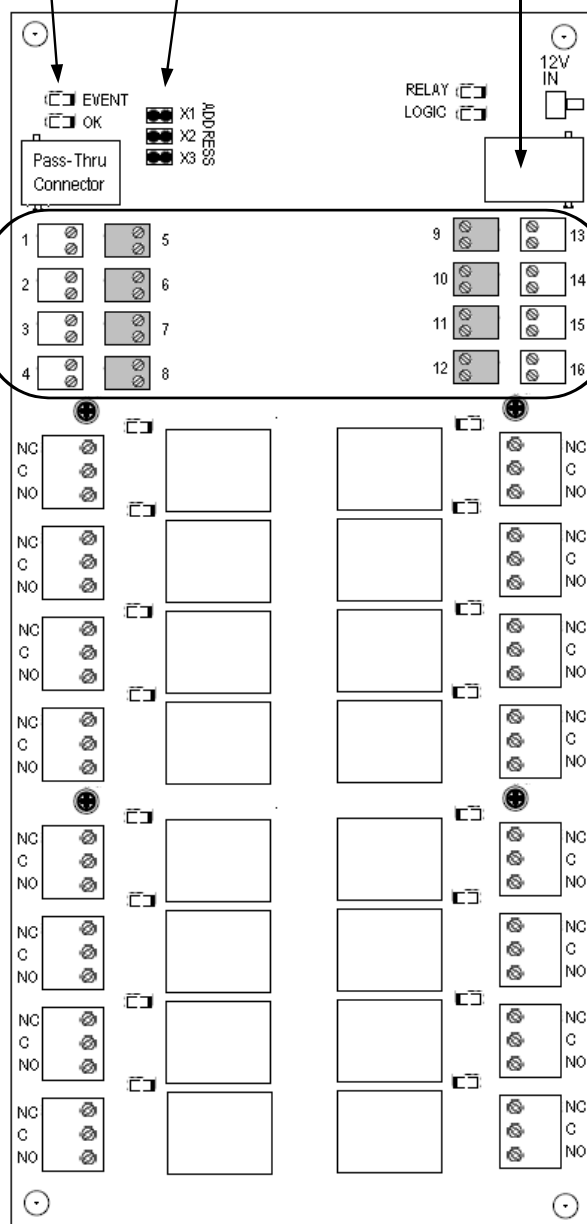
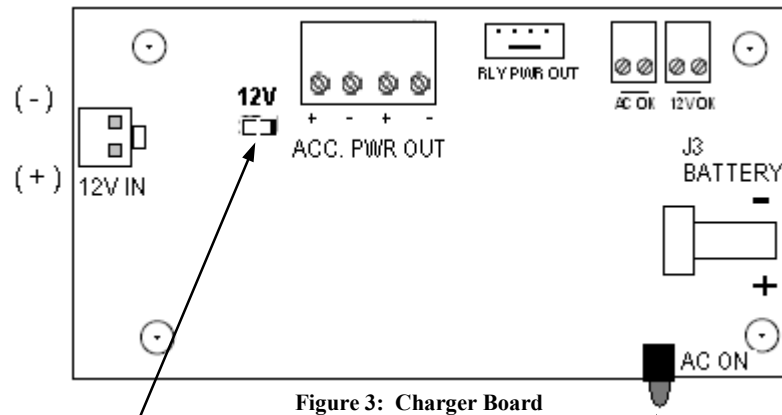

Figure 2 - PC Board Layout

PC Board Layout: Charger Board in CICP1300IOCOMBO



INDICATORS

- **12V** - Indicates 12 volt power working, either from the power supply (Mains) or from the backup battery.
- **AC ON** - Indicates Mains power connection working (lights through to the front panel)

12V IN - Normally connected at the factory to the 12 volt output of the power supply.

ACC. PWR OUT - Provides battery-backed 12 volt DC power for accessory equipment, such as sounding devices, PIR sensors, electric locks, etc.

RLY PWR OUT - Provides battery-backed 12 volt DC power for the relay coils of the Alarm/Relay Boards (CICP1300IOBD) mounted in the enclosure. Use with the special cable provided.

AC OK - This output provides AC power supervision. When AC power is operating, this output is a closed circuit, and may be connected to normally-closed alarm circuits. Note that this is an open-collector output of a transistor, and that the right terminal is grounded. The right terminal must always be connected to the return side of an alarm input (this is always the lower terminal on the Alarm/Relay Board and the alarm inputs of the Super Two Access Control Panel). AC power failure is signaled when AC power is lost or when this supervision circuit is opened.

12V OK - This output provides 12 VDC power supervision. Note that the output will be open in the faulted condition, and does not depend upon 12 volt power on the charger board. When 12 volt power is active, the open-collector output will be closed. As with the AC power supervision, the terminal on the right side must connect to the return side of an alarm input, normally the lower terminal on any alarm input on the Alarm/Relay Board or the Super Two Access Control Panel.

BATTERY (J3) - Normally, the backup battery is connected by sliding the connector into place at J3. This is a high-energy circuit, and care must be taken to keep field wiring away from this area. Be sure to maintain a distance of at least ¼" from any other wiring.

Additional Configurations

A Second CICP1300IOBD Alarm/Relay Board may be installed as described on page 22. Then, a second CICP1300IOCOMBO may be added to bring the total number of Alarm/Relay Boards to three (shown below).

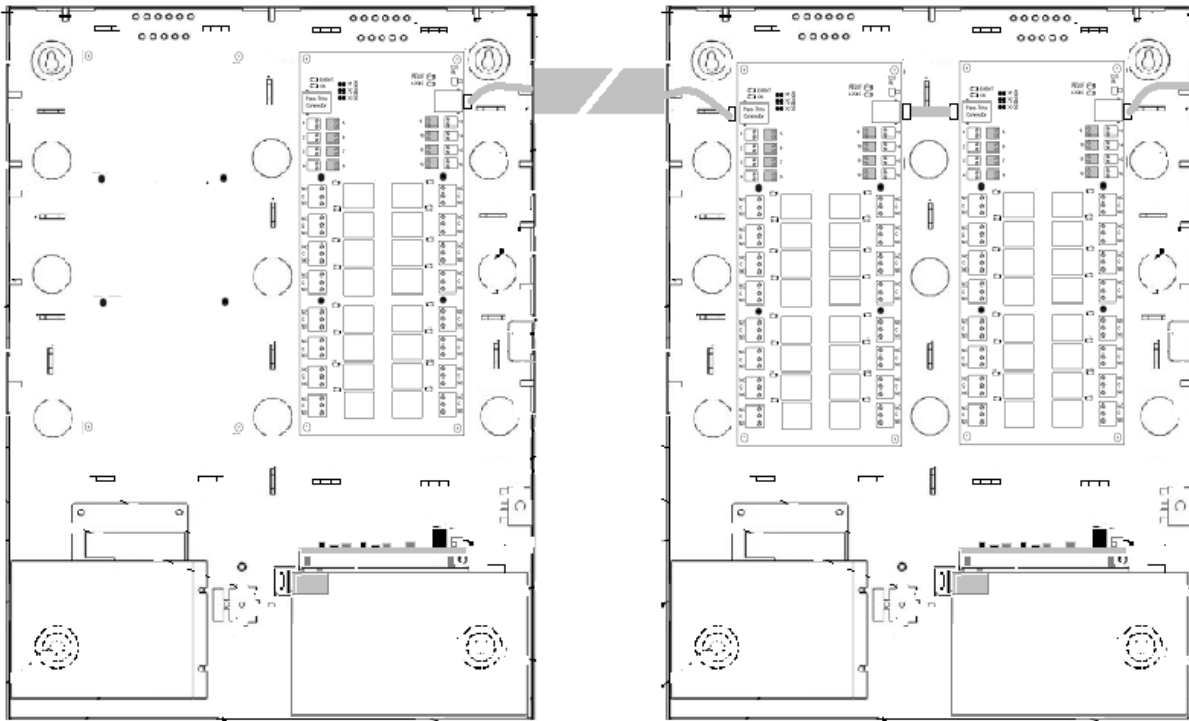

Figure 4 - Second CICP1300IOBD Alarm/Relay Board

If the additional Battery-Backed Power is not needed, a CICP1300ENCL Expansion Unit may be installed with a CICP1300IOBD Alarm/Relay Board. The wire harness provided with the CICP1300ENCL Expansion Unit allows it to be powered by an adjacent CICP1300IOCOMBO Expansion Unit or Access Control Panel, but be mindful of the 500mA load that must be met by the 12 Volt power source for each Alarm/Relay Board.

Note: The maximum total length of modular cable to be used to connect the three Alarm/Relay Boards to the Access Control Panel is 9 feet (2.74 meters).

INSTALLATION

Only qualified service personnel familiar with all local building codes should attempt this installation. Take appropriate safeguards to avoid unintentional operation by employees and maintenance personnel working about the premises.

The installation of each Expansion Unit should be completed and tested on its own before connecting into a network. Any possible wiring or installation problems are magnified many times by the complexity of the network.

Once an individual panel has been tested and found operating satisfactorily, it can then be safely brought into the network.

The Expansion Unit is categorized as PERMANENTLY CONNECTED EQUIPMENT with fixed wiring. This system must be installed within the protected premise in accordance with the National Electrical Code (NFPA70), local codes, and the authorities having jurisdiction.

A Ground Bond Strap is bolted between the Enclosure and the Door to reduce the risk of electric shock. If the Ground Bond Strap is unbolted from the Door to allow the Door to be removed, it is critical that the Ground Bond Strap be correctly attached before putting the Access Control Unit into service.

The following warnings are designed for the safety of the Ex-

pansion Unit install/service technician and for the continued proper function of the Expansion Unit.



About This Manual



This manual describes the installation of the Expansion Unit Access Control Unit and the specific accessories that connect to it.

End-User Periodic Tests and Emergency Planning

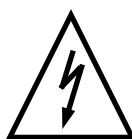
The Host Computer Software supervises the Access Control System, reporting failures at an individual panel within seconds of the occurrence. Nevertheless, failures can occur at the Door Sense and Bypass contact monitoring hardware, the individual Card Reader electronics and wiring, or the Electric Door Lock Hardware that will not be detected until the equipment is used. For this reason, please instruct staff at the installation to perform a "walk through" test at every controlled entrance and verify operation of all the monitored contacts at least once per week, especially at sites that are less frequently used. Assist the Security Staff at the installation to devise acceptable alternatives to allow entrance and monitoring of access at controlled sites impacted by equipment failures, especially in high-traffic areas.

Provide staff members at the facility with contact information that will help assure the swift correction of equipment outages.

<p>NOTES:</p>	<p>Notes are included with a procedure informing the installer about related material.</p>
<p>CAUTION</p> 	<p>Cautions indicate that a particular process requires special attention.</p>
<p>WARNING</p> 	<p>Warnings indicate that a particular process exposes the installer to live circuits or that making wrong connections can lead to equipment failure.</p>
<p>CAUTION</p> 	<p>Do not place accessory circuit cables in the same conduit sections containing power cables.</p>

<p>CAUTION</p> 	<p>Prevent the risk of a fire by replacing ALL fuses with the same type and rating. The main fuse protects the power supply circuit against excessive currents and short circuits. Failure of the power supply (other than a blown fuse) fuse usually indicates a fault in a power supply component. There are no user-serviceable parts in the Expansion Unit cabinet. The power supply must be replaced if it fails.</p>
<p>WARNING</p> 	<p>The lower part of the power supply has exposed terminals and components (see page 15). DO NOT probe the power supply and expose yourself to high voltage and a shock hazard.</p>
<p>WARNING</p> 	<p>The risk of a serious electrical shock exists if the wiring harness power connector is removed from the Expansion Unit circuit board, but AC power remains live at the AC Input Power Terminal Block (see Figure 9, page 15).</p>

INSTALLATION

Installation Preparation

First, select a mounting location within a secure, limited access area (see Figure 5). Note the type of wall construction that the enclosure will be secured to.

- Determine that adequate space is available for mounting the Expansion Unit cabinet on a wall with no interference from wires, pipes, or other obstructions.
- Proper installation of the Expansion Unit cabinet requires an area of free space measuring at least:

23 inches high (584mm)
X
20 inches wide (508mm)
X
4.0 inches deep (101.6mm)

- Confirm that adequate free space exists on both sides of

the Expansion Unit cabinet for cabling conduit entering and exiting the cabinet.

- Determine the directions of the cabling conduit exiting the Expansion Unit cabinet. Confirm sufficient access to ceilings and/or walls before fitting the conduit lengths.
- Knockouts at the back of the unit may be used for "hidden wiring" installations.

NOTE: All Expansion Unit signal wiring and accessory power circuits are certified as power limited. The use of conduit is optional for these circuits.

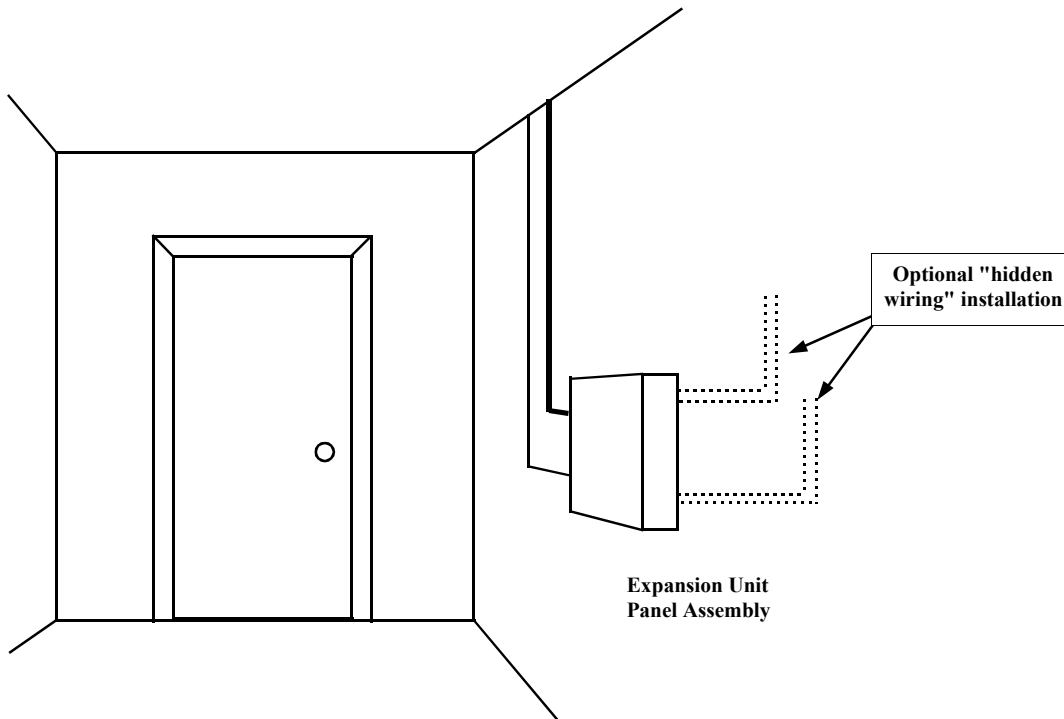

Figure 5 - Expansion Unit Installation Location

Cabinet Mounting

Inspect the mounting surface around the proposed installation site. The mounting surface must be capable of supporting 17 pounds (7.6Kg) plus any additional weight of the installation hardware.



CAUTION
Use only suitable mounting hardware for the type of wall construction encountered.

Disconnect the battery, preferably by sliding off the “Molex” connector on the Charger Board, then carefully remove the backup battery and its associated clamp by removing three screws. Please save these screws for later use.

1. Determine the Expansion Unit cabinet mounting location. Keep in mind that conduit will be used to connect the Expansion Unit to the Super Two Access Control Panel. If the tops of the enclosures are kept on the same line, the conduit connection will be simplified. The Expansion Unit will normally be to the left of the Super Two Access Control Panel.
2. Mark the four mounting holes against the mounting surface using the Expansion Unit cabinet as a template, or using the measurements provided in Figure 6.

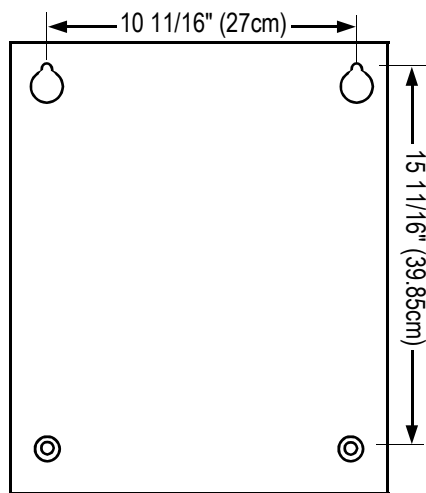

Figure 6 - Expansion Unit Cabinet Mounting Hole Dimensions

NOTE: Mark the small oval portion of the cabinet screw holes (see Figure 7, Detail A and B, below).

3. Place the Expansion Unit cabinet out of the way.
4. Drill pilot holes to the required depth and size for the mounting screws.
5. Insert the top two mounting screws into the wall. Leave approximately one quarter of the screw's length protruding from the wall.

NOTE: Do not tighten screws completely at this time.

6. Place the Expansion Unit cabinet over the mounting screws. Secure the Expansion Unit cabinet to the mounting surface using the two lower screws, and then tighten the remaining length of the screws.
7. Re-install the back-up battery and bracket using the screws that were saved as advised above. Slide the Molex connector back into its place.

NOTE: Because of the Low Battery Voltage Disconnect feature, the Expansion Unit 12 volt output will not start to operate until Mains (AC) power is connected.

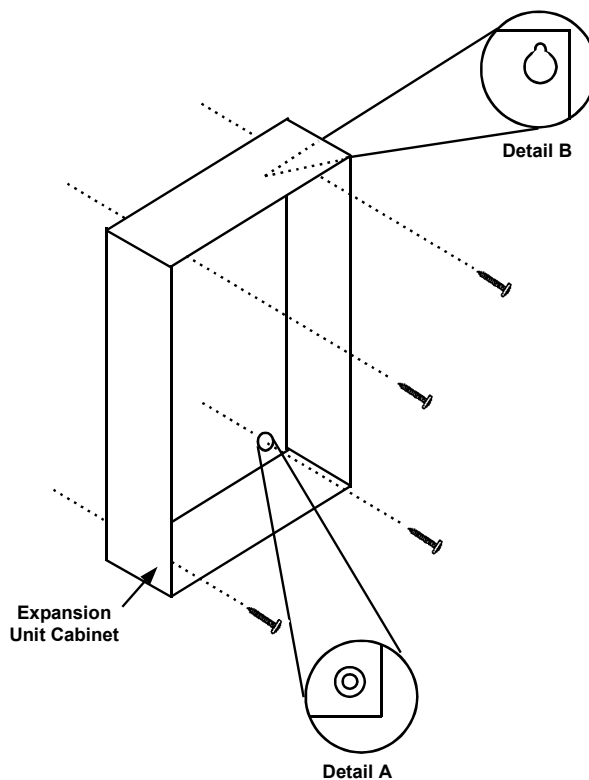

Figure 7 - Expansion Unit Mounting Screws

INSTALLATION

Cable and Wiring Categories

The wiring and cabling for the Expansion Unit are divided into three categories:

Mains Power Cables and Wiring

This category contains Mains AC power cables servicing the Expansion Unit Panel. The connection to the Mains must be carried out by qualified personnel.

Low-Voltage Power and Accessory Relay Devices

12 or 5 volt Power, any accessory relay controlled devices connected to the Panel, and any 12 volt Accessories receiving battery-backed power from the panel. (These are power-limited circuits, and normally do not require a licensed electrician to complete this work). The wiring inside the enclosure must be kept at least 1/4" away from the high-power (black and white pair) wires between the AC Terminal Block and the Power Supply, as well as the Red and Black Leads between the Battery and the PC Board.

Communication Cables

This category contains all the communication cabling between the Expansion Unit and all communication equipment, all alarm circuits, and all card reader devices. (These are power-limited circuits, and normally do not require a licensed electrician to complete this work). The wiring inside the enclosure must be kept at least 1/4" away from the high-power wires, as described in the paragraph above. **NOTE:** For proper operation of the Expansion Unit, route EACH category of cabling in SEPARATE conduit or bundle (i.e.,



DO NOT mix alarm and communication cables in the same conduit as relay and power cables). Plenum-Rated cabling may be required in certain installations. See Important Safety Information, page 6.

Incoming Power Conduit Knockout

The Expansion Unit requires the Mains Power Cable be connected to the AC Input Terminal Block. (see page 15). The

power cabling is delivered to the Expansion Unit through a knockout located on the lower center of the left side cabinet wall (see Figure 8). The 3/4 inch knockout accepts EIA standard conduit connectors.



NOTE: This system must be installed within the protected premise in accordance with the National Electrical Code (NFPA70), local codes, and the authorities having jurisdiction.

Accessory Conduit Knockouts

All cabling for the Expansion Unit is routed through EIA standard 3/4-inch knockouts located on the left and right sides of the cabinet (see Figure 8). On the top of the enclosure, three-size knockouts are available.

Grounding Accessory Drain and Shield Wires

Ensure electromagnetic compatibility and reliable performance by keeping all accessory drain and shield wires as short as possible.

All accessory drain and shield wires connect to ground posts mounted along the knockout strips on both sides of the Expansion Unit cabinet (see Figure 8).

The following procedures assure proper installation of all drain and shield wires.

- Carefully remove the cable jacket after the cable enters the Expansion Unit cabinet.
- Place the drain wires under the ground post screw. Trim as needed.
- Verify a good connection and tighten the ground post nut.
- Connect the accessory wires to the appropriate terminal strip on the Expansion Unit circuit board.

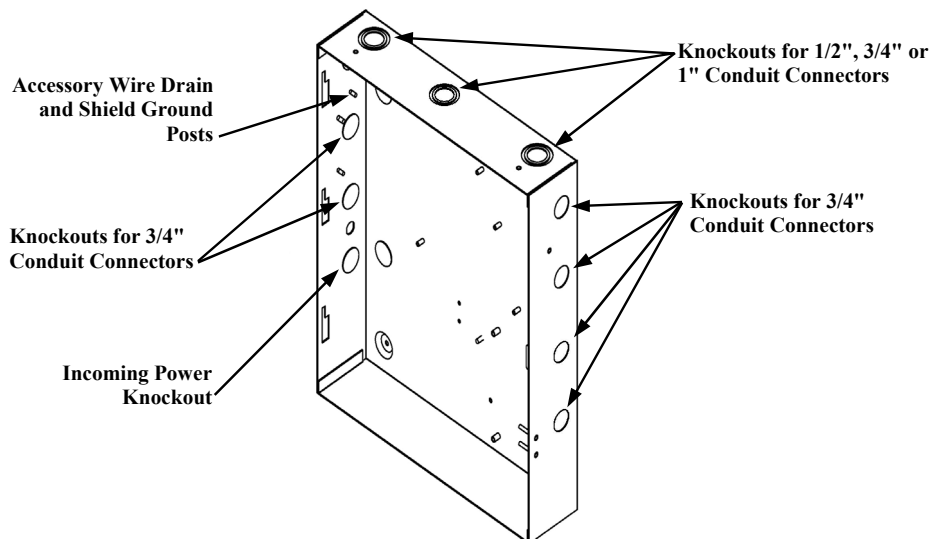

Figure 8 - Cabling Conduit Knockouts

POWER CONNECTIONS

AC Power Source Grounding

The Expansion Unit main circuit board has built-in surge suppression devices. The surge suppressors require a good earth ground connection to operate effectively.



WARNING

Verify that the AC source voltage is switched off at the breaker panel before proceeding with connections.

AC Power

The incoming AC source voltage connects to the AC Input Power Terminal Block located in the lower middle of the Expansion Unit cabinet (see Figure 9).

Run the AC power wiring through a knockout normally hidden by the insulation cover. Do not place any other wiring in this area.

First, secure the Green or Green/Yellow "Ground" wire to the center terminal of the AC Input Terminal Block. Then secure the White "Neutral" wire to the left terminal. Finally, secure the Black "Line" wire to the right terminal.

After the wiring is completed, use a cable-tie to secure the wires to the cable-tie mount (provided) located below the AC Input Power Terminal Block.



NOTE: Use of a dedicated, unswitched AC power source results in optimal performance with minimum interference.

Table 1 lists the incoming AC source voltage connections to the AC Input Power Terminal Block.

NOTE: Knockouts for conduit Fittings are located on the back of the metal housing and can be used if "hidden cable" installation is required.

IMPORTANT SAFETY REQUIREMENTS:

The Disconnect Current Rating for the Circuit Breaker must be 15 Amps or less.

If the enclosure door is removed, the Ground Strap may be unbolted--but MUST be REATTACHED after installation or service is completed. Failure to Reconnect the Ground Strap may increase the Risk of Electric Shock.

NOTE: Because of the Low Battery Voltage Disconnect feature, the Expansion Unit will not start to operate until mains (AC) power is connected.

Incoming AC	Wire Color	AC Input Terminal Block
Line	Black	L
Neutral	White	N
Ground	Green	

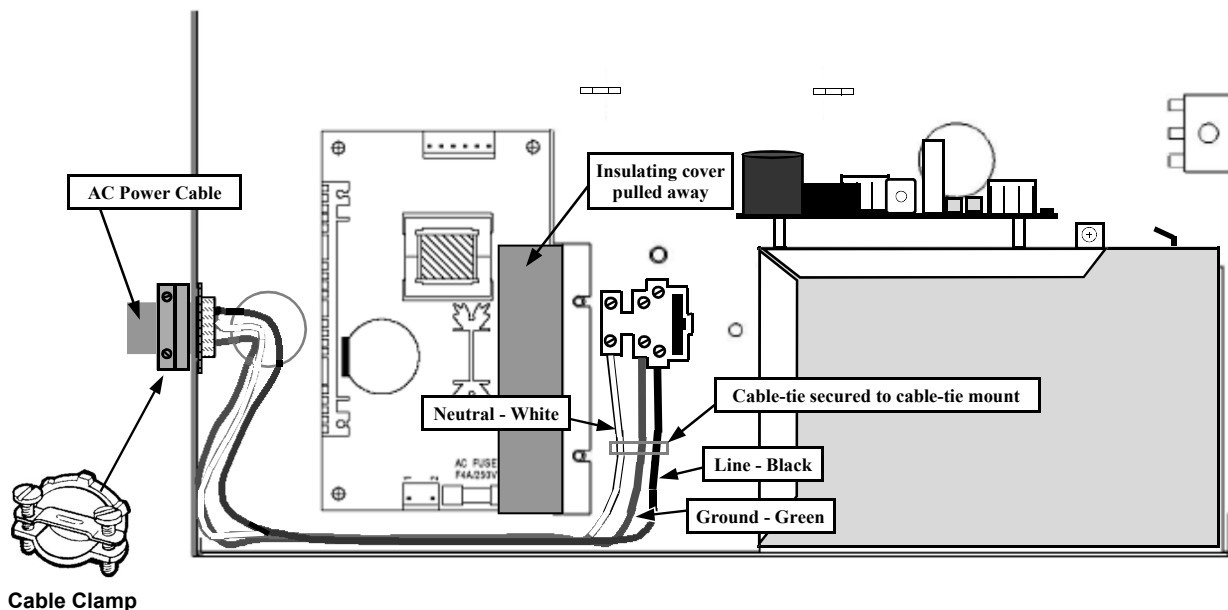

Figure 9 - AC Input Power Terminal Block

MODULAR CABLE

Modular Cable

The Modular Cable carries Alarm Data to the Access Control Panel and Relay Activation commands from the Access Control Panel. The modest power requirements of the Logic and Alarm Circuits are provided from the Access Control Panel through this cable. The relay coil power is supplied through the 12V IN connector just above the Modular Jack on the right side of the board.

The first Alarm/Relay Board must connect to the Access Control Panel using the Jack on the right side of the board. A Pass-through connector is on the left side of the board if additional boards are used. Always connect the cable between the left of one board to the right of the next board. If this rule is

not followed, the product will not be damaged, but the system will not work correctly.

The Modular Cable must be run through metal conduit between the system enclosures. The total length must not exceed 9 feet (2.74 meters).

When removing the cable, note that the latching lever is on the side near the printed circuit board.

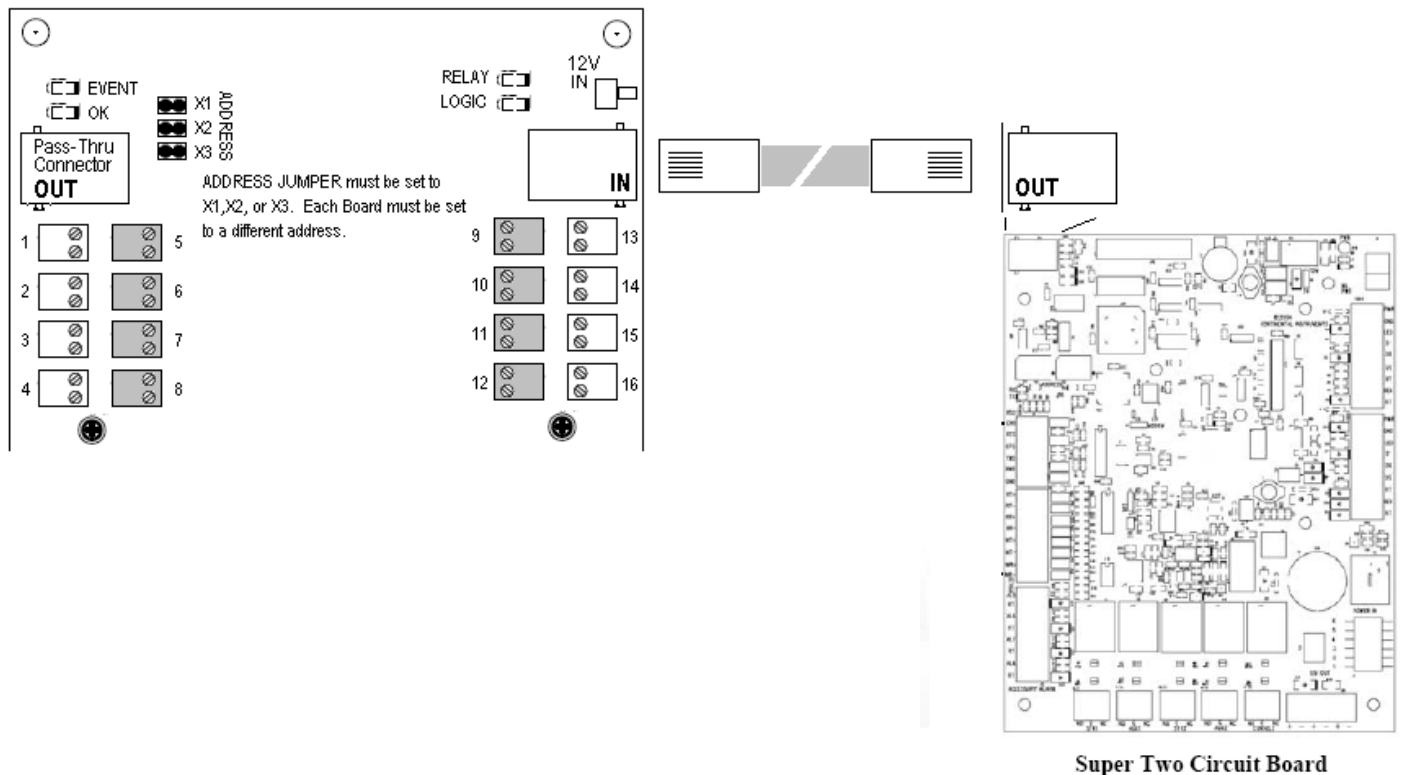

Figure 10 - Modular Cable

ACCESSORY POWER

The ACCESSORY POWER terminal strip (labeled **ACC PWR OUT**) provides battery backed +12VDC power outlets for auxiliary devices. This terminal strip is located in the lower right-hand corner of the Expansion Unit enclosure.

Table 2 lists the **ACC PWR OUT** terminal strip pin numbers and their associated functions.

Table 2 - ACCESSORY POWER (ACC PWR OUT) Terminal Strip Functions	
Pin	Function
1	+12
2	GND
3	+12
4	GND

NOTE: +12VDC current draw is limited to a total maximum of 1.60 Amps for Readers, EM Locks, and Accessories.



WARNING
Observe Positive and Negative wire polarity between accessory devices and the Expansion Unit.

RELAY POWER

The CICP1300IOCOMBO Expansion Unit with power supply, battery and Charger Board provides a convenient connection for relay power. To the right of the **ACC. PWR OUT** connector, find a 4-pin header marked **RLY PWR OUT**. A cable is provided to connect this 4-pin header to the two 2-pin headers marked **12V IN** on the upper-right of the Alarm/Relay board.

RELAY CONNECTIONS

RELAY CONNECTIONS

Description

Each Alarm/Relay board provides sixteen Form C relays to control Area Entry, Shift Signaling Devices, etc. If used to control high-voltage equipment such as outdoor lighting in parking areas, a suitably-wired external relay must be added to switch the high-voltage equipment.

Relay Characteristics

The relays all share the following characteristics:

- Form C relay with a contact rating of 2A at 24V AC/DC.
- The Normally Open (NO), and the Normally Closed (NC) contacts are the default state of non-energized relays. An

LED located near each relay will light when the associated relay is activated.

- Metal oxide varistors (MOVs) are placed across the contacts to reduce electrical noise. The MOVs limit any noise caused by the switching an inductive load to 56 volts.

NOTES:

- Installing a 56V MOV at the controlled device further reduces possible noise input.
- Additional MOVs are available from Continental Instruments as part number R783R.
- Because of this noise, relay wiring **MUST NOT** be put in the same conduit with other wiring.

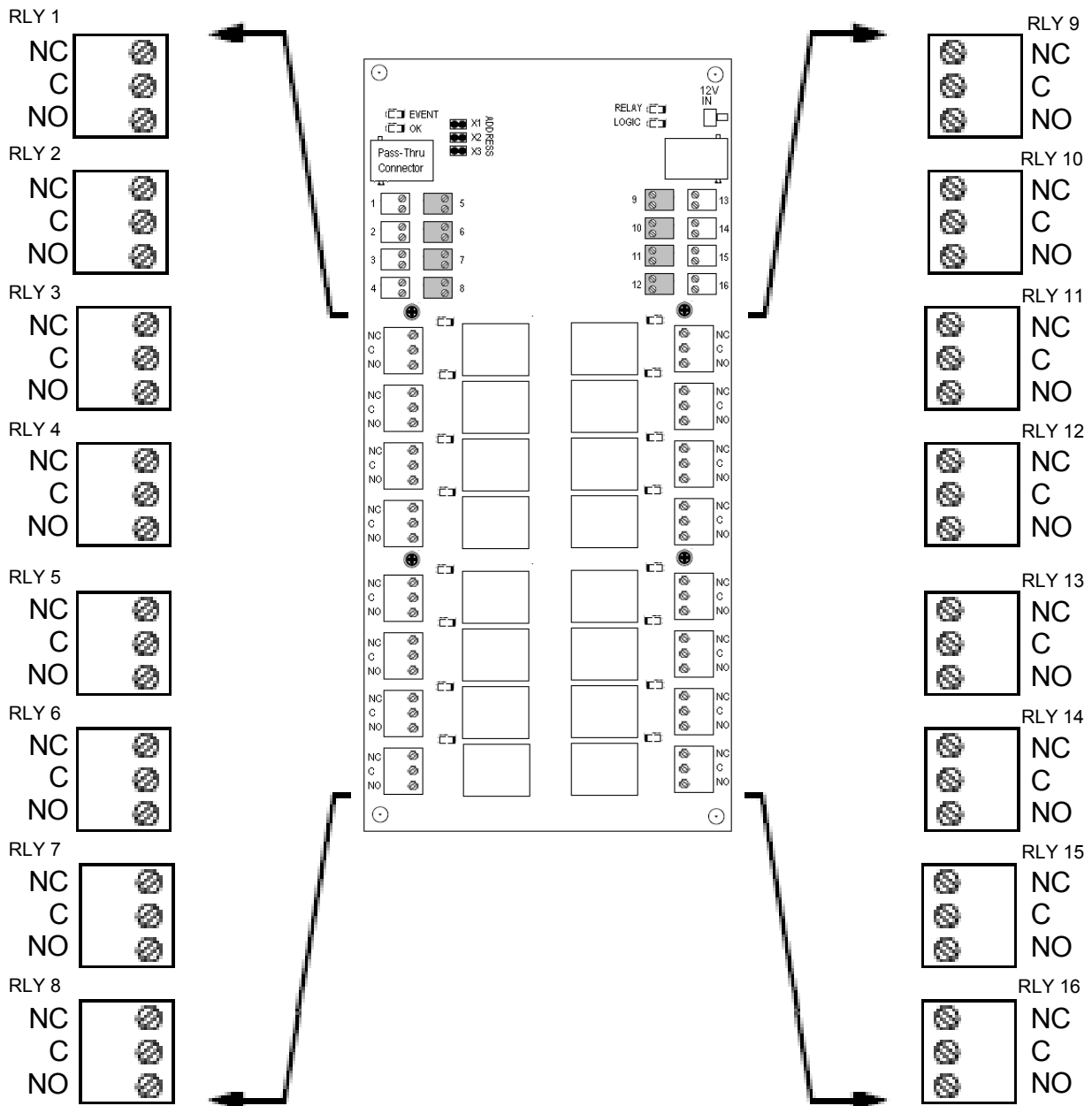

Figure 11 - Relay Contact and Accessory Power Outputs

ALARM CONNECTION

Each Alarm/Relay Board has a total of 16 supervised alarm inputs. These are located on the top portion of the PC Board. The inner columns use "Riser" Headers to ease wiring. (see Figure 12). These alarm inputs may be used for dry contact type inputs (unsupervised) or supervised alarms.

Supervised Alarms

Supervised alarms provide monitoring of alarm inputs for fault or tamper conditions. Two additional alarm states may be detected by installing two-1K ohm resistors near the alarm contacts. In addition to the standard Normal and Abnormal alarm conditions, the supervised alarms report line open and line short conditions.

- A line open condition is the result of a cut wire.
- A line short condition is the result of a short in the alarm wiring.

These fault conditions may be the result of tampering, and indicate the system cannot correctly detect the state of the alarm contacts.

Configuring an Alarm in the Supervised Condition

1. Use two 1K Ohm, 1/4W, $\pm 5\%$ carbon film resistors per alarm.
2. Install R1 in parallel with the alarm contacts (see Figure 12).
3. Install R2 in series with the alarm input conductor.

NOTE: For maximum protection, install the resistors close to the alarm contacts and embed them in epoxy.

Alarm Cable Requirements

Connecting alarm sensors to the expansion board requires 22 AWG, stranded, shielded cables with drain wires.



CAUTION

Keep all drain wires short. Connect drain wires to the ground posts located on both sides of the Expansion Unit cabinet. DO NOT ground drain wires at any other point.

Tamper Switch

The Expansion Unit Enclosure has a built-in tamper switch. The tamper switch is supplied with wiring sufficient to connect to an Alarm Input of the Access Control Panel, and may be extended with an in-line terminal block if desired. The Tamper switch wiring may be run in the same conduit with the modular cable connecting the Expander Board to the Access Control Panel. The leads may also be trimmed to connect to one of the Alarm/Relay Board Alarm Inputs. The Tamper switch is normally-closed when the enclosure door is closed. The tamper switch must be configured at the Host Computer to signal an Alert when the tamper switch is activated. The tamper switch may also be configured to activate the Console Relay that is wired to an alarm signal circuit or an alarm sounder.

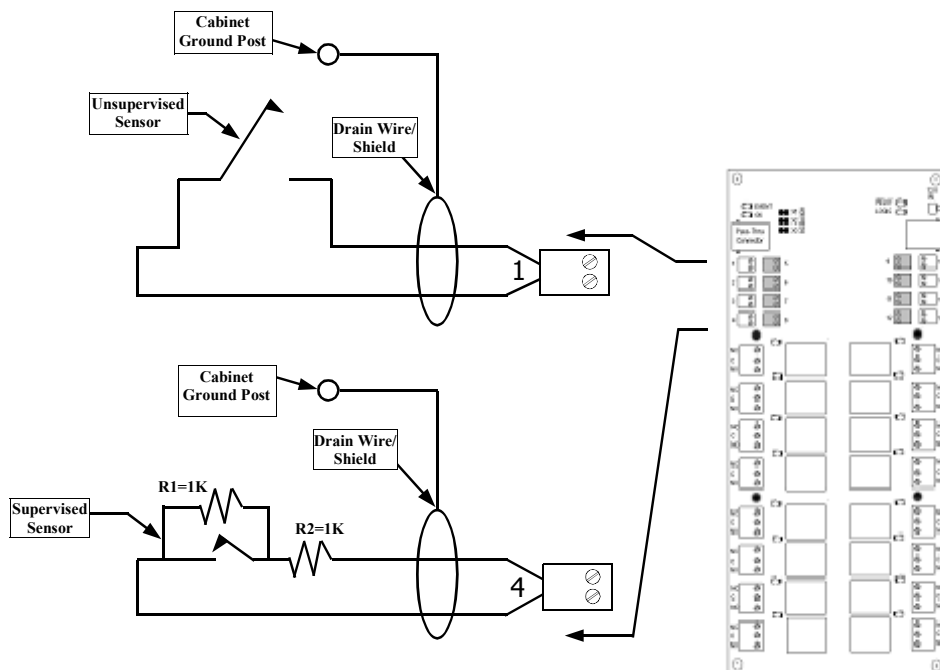

Figure 12 - ALARM Terminal Strip - Unsupervised and Supervised Alarm Connections

Expansion Unit Primary Fuse - 120VAC Installations (USA/Canada)



A 1-ampere (1.00A) 5x20mm slow-blow, UL approved fuse protects the Expansion Unit primary circuit. The fuse is located on the service entrance terminal block on the bottom of the Expansion Unit . (see Figure 13). The fuse holder is “shocksafe,” and may be carefully removed while the unit is powered.

1. Find the service entrance terminal block near the bottom middle of the enclosure.
2. Grasp the black fuse holder and pull straight out.
3. Replace the fuse with a 1-ampere (1.00A) 5x20mm slow-blow, UL approved fuse.
4. Re-install the fuse holder with the new fuse.

Expansion Unit Primary Fuse - 120/230VAC Installations (European Union)



A 1-ampere (1.00A) time delay fuse meeting IEC standards protects the Expansion Unit primary circuit. The fuse is located on the service entrance terminal block on the bottom of the Expansion Unit (see Figure 13). The Fuse Holder is “shocksafe,” and may be carefully removed while the unit is powered.

1. Find the service entrance terminal block near the bottom middle of the enclosure.
2. Grasp the black fuse holder and pull straight out.
3. Replace the fuse with a 1-ampere (1.00A) 5x20mm time-lag, IEC127 approval fuse.
4. Re-install the fuse holder with the new fuse.

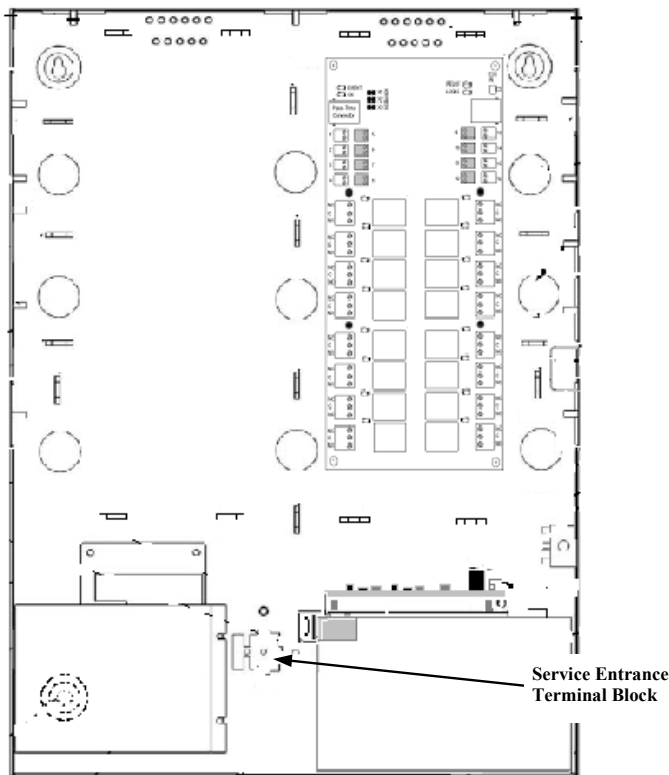

Figure 13 - Expansion Unit Primary Fuse Location

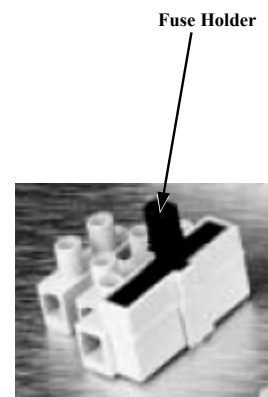

Figure 14 - Fuse Holder

Expansion Unit Power Supply Fuse

A 4-ampere (4A) fast-blow fuse mounted on the lower part of the power supply circuit board, provides protection to the power supply from high-energy surges. If this fuse faults frequently, consider adding a UL-1449-Listed power-line surge protection device.



WARNING

Verify that the main AC power to the Expansion Unit cabinet is switched OFF and locked against accidental starting.

- 1) Turn OFF the main circuit breaker controlling power to the Expansion Unit cabinet.
- 2) Pull the insulating fishpaper cover away from the power supply.
- 3) Using a non-conducting fuse puller, remove the old fuse (see Figure 16).
- 4) Replace the fuse with a 5x20mm, 4-Amp, 250V, fast-blow (not a time-lag) fuse.
- 5) Reset the main circuit breaker.

Expansion Unit Accessory Circuit Protection



A 3.0 Amp resettable fuse protects the battery charger circuit, and a 2.5 Amp resettable fuse limits the output to the accessory circuits to safe levels. These devices limit the accessory current even when the product is operating under backup power from the battery.

Under conditions of moderate overloads, the power supply will shut down its output, but periodically power-up briefly to test to determine if the overload is removed. This will be visible because the PWR Lamp will flash on about once per second. Power will be restored immediately upon removal of the overload condition.

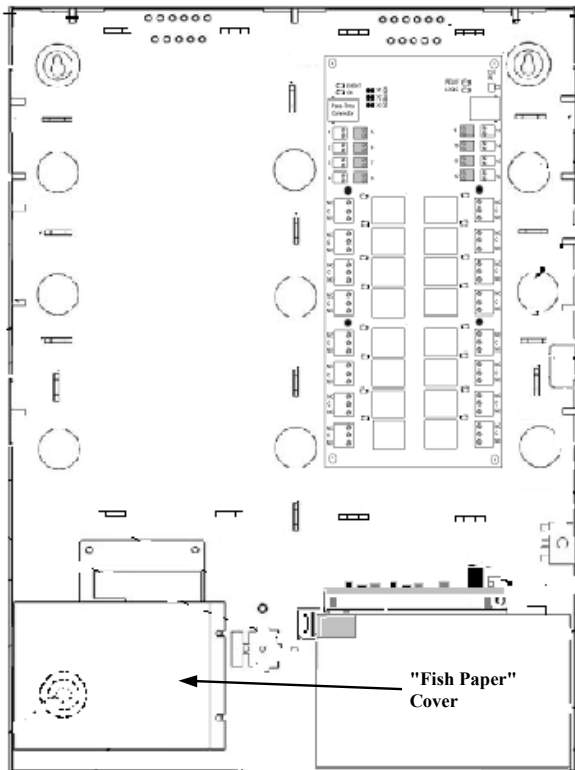

Figure 15 - Expansion Unit Power Supply Fuse Location

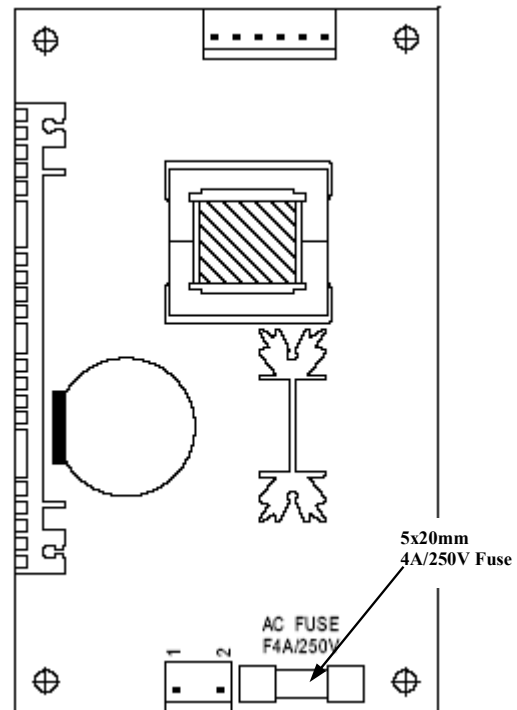

Figure 16 - Power Supply Fuse Location

INTERNAL EXPANSION

Installing the Second Supervised Alarm/Relay (CICP1300IOBD) Board

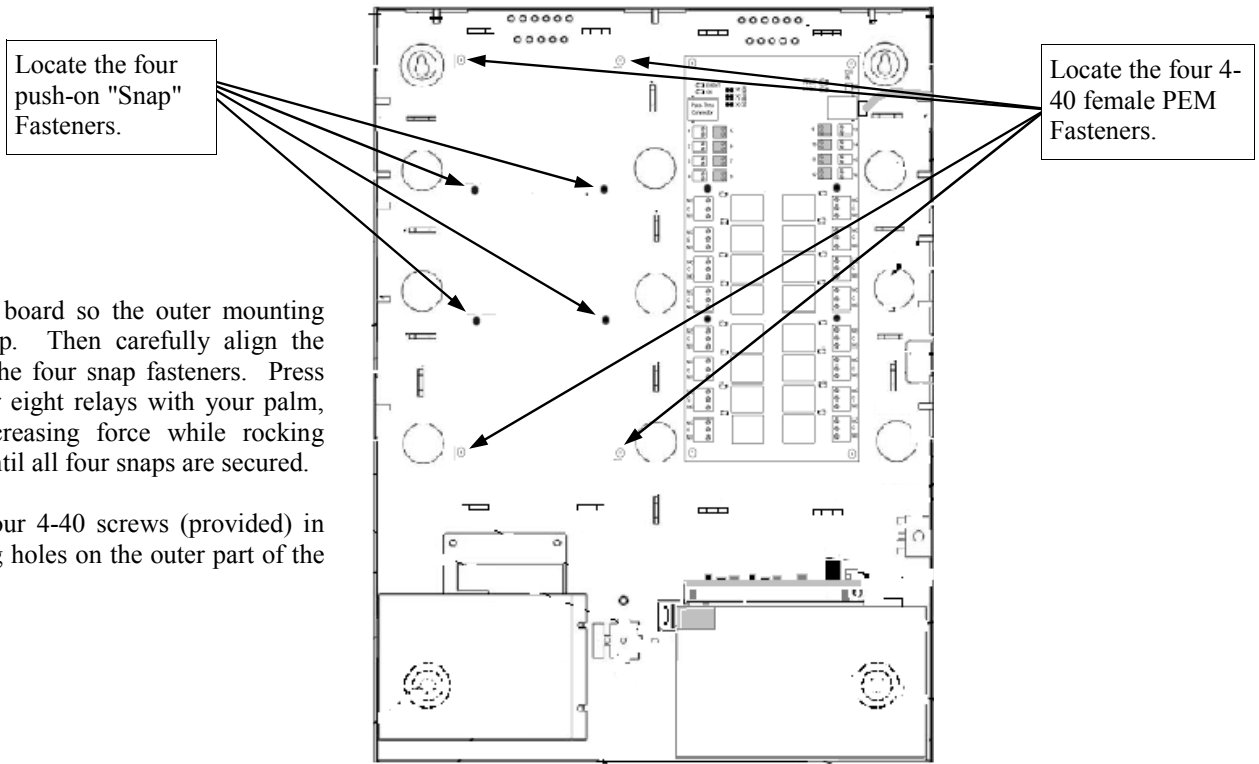

Figure 17 - Fastener Mounting Locations

Locate the **12V IN** connector on the upper-right of the board.

When being installed in the CICP1300IOCOMBO (with the power supply and battery) connect the small white Molex Connector from the cable plugged into **RLY PWR OUT** Connector.

When installed in the CICP1300ENCL (without the power supply and battery) use the long cable provided to connect to the Accessory Power Connector in the Access Control Panel. Note this cable may be routed with the Modular cable in the same conduit.

Connect the Short Modular Cable (provided) between the two Alarm/Relay boards.

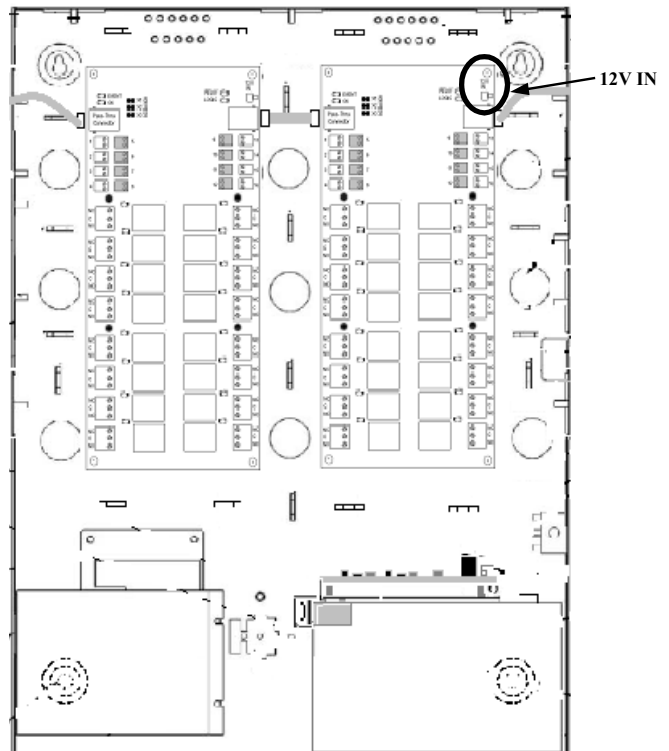

Figure 18 - Power Connection Locations

MAINTENANCE

Power Supply Replacement

The following procedure applies after determining that the Expansion Unit power supply (P/N MX1106) needs replacing.



WARNING

Verify that the AC source voltage is switched off at the breaker panel before proceeding with power supply replacement.

1. Open the Expansion Unit cabinet and locate the 12VDC power supply in the lower left corner of the cabinet. Pull the insulating cover out of the way.
2. Disconnect the lower Molex connector from the power supply (one black and one white).
3. Disconnect the upper 6-pin Molex connector from the power supply.
4. Remove the four 6-32 screws securing the power supply bracket to the Expansion Unit cabinet.
5. Remove the power supply from the Expansion Unit cabinet.
6. Install the new power supply in the reverse order of the removal.

Backup Battery Replacement



WARNING

Verify that the AC source voltage is switched off at the breaker panel before proceeding with backup battery replacement.

1. Open the Expansion Unit cabinet and locate the backup battery (P/N CI-HE0042) secured to the lower right of the cabinet.
2. Disconnect the RED lead from the POSITIVE terminal of the battery.
3. Disconnect the BLACK lead from the NEGATIVE terminal of the battery.
4. Remove the three screws securing the battery bracket.
5. Remove the old battery.
6. Install the new battery in the reverse order of the removal.
7. Replace the battery bracket. Replace the three screws and tighten.
8. Replace the Backup Battery at least once every five years.

NOTE: Because of the Low Battery Voltage Disconnect feature, the Expansion Unit will not start to operate until Mains (AC) power is connected.

SPECIFICATIONS

SPECIFICATIONS

SPECIFICATION	Quantity	Comments
Relays	16 (each PDB) per panel. 48 Max.	Form "C", contact rating of 2A @24V ac/dc
Alarms	16 (each PDB) per panel. 48 Max.	Supervised or non-supervised (host programmable)
Status LEDs	16 4 2	One LED per relay EVENT, OK, RELAY power, LOGIC power 12V out, AC ON. (Charger Board)
Tamper Switch	1	
Supply Voltage		120/230 VAC 60/50Hz
Current Draw		1.0A @ 120VAC; 0.5A@230VAC
Accessory 12V Output	2	1.6A for Readers, Locks, and Accessories. Battery Backed.
Battery Backup		Approx. 4 hours.
Weight		17 lbs. (with 7AH battery installed)
Enclosure Dimensions (H x W x D)		18.75" x 13.85" x 3.25" (47cm x 35.2cm x 8.3cm)
Temperature Range Operating Storage		32-115°F (0-46°C) 32-149°F (0-65°C)
Relative Humidity		0% to 85% non-condensing
Link Programs	64	Standard

Cables	AWG	Type	Maximum Length
Alarm Inputs	22 ga	Stranded, shielded, w/drain 2-conductor alarm	500 ft (153m)
Relay Circuits	18 ga	Stranded, shielded, w/drain	500 ft (153m)

POWER RATINGS

As supplied from the factory, the CICP1300IOCOMBO Expansion Unit contains a Power Supply that operates on 120VAC/60Hz for North America, or 230VAC/50Hz for the European Union.

Continental Instruments recommends using a dedicated, unswitched power outlet to prevent any interference from other equipment that might be connected on the same line.

Voltage	Current (Maximum)
120VAC	1.0 Amperes
230VAC	0.5 Amperes
Accessory Output- 12VDC	1.6 Amperes*

*Including Readers, EM Locks, and Accessories such as PIR Sensors.

SUPER TWO EXPANSION BOARD MAPPING

Expansion Board #1

Relay	Input
5	9
6	10
7	11
8	12
9	13
10	14
11	15
12	16
13	17
14	18
15	19
16	20
17	21
18	22
19	23
20	24

Expansion Board #2

Relay	Input
21	25
22	26
23	27
24	28
25	29
26	30
27	31
28	32
29	33
30	34
31	35
32	36
33	37
34	38
35	39
36	40

Expansion Board #3

Relay	Input
37	41
38	42
39	43
40	44
41	45
42	46
43	47
44	48
45	49
46	50
47	51
48	52
49	53
50	54
51	55
52	56

VIRTUAL INPUTS

Reader 1	
Function	Input
Forced Door	49
Valid Tracked	50
Void /Denied Card	51
Open Too Long	52

Reader 2	
Function	Input
Forced Door	53
Valid Tracked	54
Void /Denied Card	55
Open Too Long	56

NOTE: Virtual Inputs are not available if Expansion Board # 3 is used.

WARRANTY / TERMS & CONDITIONS

Standard Terms of Sale

Ordering

Orders for Continental products may be placed by calling Continental's order department or by issuing a purchase order specifying the quantity of Products, the desired delivery date, shipping method, and the location to which product should be shipped. If an order is placed by telephone, it must be confirmed in writing by fax or mail.

If the customer requests a guaranteed ship date or expedited shipping, Continental reserves the right to add to the price, with the customer's approval, expenses which increase the cost of production and delivery, i.e. freight charges, overtime expenses, etc. Continental reserves the right to change any price on this price list and all prices are subject to factory reconfirmation at the time of placing an order.

Sales Assistance

Continental will furnish to customers, reasonable quantities of product-related catalogs and other sales and promotional literature.

Continental will provide customer training, both technical and sales at Continentals facilities in New York. Contact the factory for costs and requirements.

Payment Terms

- Sales terms are Cash on Delivery (COD) unless prior credit arrangements are established.
- If credit arrangements are established with Continental, terms of sale are net 10 days.
- Interest charges shall accrue on all past due accounts at a rate of 1.5% per month (18% APR).
- Continental reserves the right to place a customer on a C.O.D. status in the event that customer's account becomes delinquent or Continental becomes unsure about customer's financial capabilities.
- Continental will charge a Service Fee of \$50.00 for any returned check.

- If customer believes an invoice to be in error, customer shall notify Continental of the error within thirty (30) days.
- Continental reserves a security interest in all products sold hereunder, together with all proceeds thereof to secure the performance of the customer's obligations hereunder.
- All orders unless otherwise requested are shipped F.O.B. Amityville, NY.

Cancelled Orders

Special or custom order items that cannot be cancelled with our suppliers are subject to a 100% cancellation charge.

No unauthorized, returned merchandise will be accepted for credit.

Orders returned or canceled are subject to a 25% restocking charge.

Return Material Authorizations

No products will be accepted for return to Continental without prior written authorization (RMA). Unauthorized returns will not be accepted from the carrier by the receiving department. The customer may request a return material authorization (RMA), whether for credit or repair of the product. Continental will either issue an RMA or provide the customer with a written explanation for not issuing the RMA. Except for warranty claims, no returns will be accepted more than 60 days after shipment from Continental. Orders that are accepted for return are subject to a 25% restocking charge. No product will be accepted for return which has been special ordered or custom in nature.

Limited Warranty

Return Material Authorization (RMA) numbers are required to be issued by Continental prior to returning any Product for service, repair, credit or exchange. Continental warrants that its Products shall be free from defects in materials and workmanship for a pe-

riod of one year from date of shipment of the product to purchaser. The warranty on 3rd party equipment such as terminals, printers, and communications devices shall be 1 year from date of shipment. Remediation of this warranty shall be limited to the repair or replacement of those products which are defective or become defective under normal use. Continental's warranty shall not extend to any product which is found after examination to be defective as a result of misuse, improper storage, incorrect installation, operation or maintenance, alteration, modification or accident.

There are no other warranties which extend beyond this provision. This warranty is in lieu of all other warranties whether express, implied or statutory, including implied warranties of merchantability or fitness for any particular purpose. No representation or warranty of the distributor shall extend the liability or responsibility of the manufacturer beyond the terms of this provision. In no event shall Continental be liable for any costs, loss of profits, loss of use, incidental, consequential or special damages to any person resulting from the use of Continental's products.

The above limited warranty is the only warranty provided by Continental. Continental makes no other warranties or guarantees, whether expressed or implied, including, but not limited to, warranties and/or guarantees of merchantability or fitness for a particular purpose. In no event shall Continental be liable for any indirect, consequential or incidental damages, including those to person and those for lost wages, or other economic loss.

Product Liability

Continental's sole Liability and the customer's exclusive remedy for damages, shall not exceed the cost of correcting the defect and in no event shall such liability be greater than the purchase price paid by the customer for the defective equipment or software. Under

no Circumstances will Continental be liable for direct, indirect or consequential damages of any kind.

General Notices:

In order to assure that Continental's customers receive the most accurate and reliable information possible, Continental at times monitors telephone calls

Information and pricing contained within this document are subject to change without notice.

Continental does not recommend that these products be used as the primary means of monitoring, warning or egress. Primary warning or monitoring systems should always meet local fire and safety code requirements.

This transaction shall be governed and construed in accordance with the laws of the State of New York.

Continental specifically rejects any terms or conditions stated by the customer or contained within purchase documents or correspondence from the customer which are in addition to, conflict with or limit, terms or conditions set forth herein. The customer's execution or other acceptance of this proposal or its acceptance of delivery of all or part of the goods to be delivered hereunder shall constitute customer's acceptance of the terms and conditions herein and shall be deemed to exclude any additional, conflicting or limiting terms stated by customer or contained in customer's purchase documents or correspondence.

INDEX

12V OK		CONFIGURATION	7
INDICATOR.....	9	CONFIGURATIONS	
AC INPUT POWER TERMINAL BLOCK		ADDITIONAL.....	10
DIAGRAM.....	15	CURRENT DRAW	
AC OK OUTPUT	9	SPECIFICATIONS	24
AC ON		DISCONNECT THE BATTERY.....	13
INDICATOR.....	9	EVENT	
AC POWER SOURCE GROUNDING.....	15	INDICATOR.....	8
ACC. PWR OUT.....	9	EXPANSION BOARD MAPPING.....	25
ACCESSORY 12V OUTPUT		EXPANSION POWER SUPPLY	5
SPECIFICATIONS.....	24	EXPANSION UNIT	
ACCESSORY CONDUIT KNOCKOUTS	14	REQUIREMENTS	6
ACCESSORY POWER.....	17	EXPANSION UNIT ACCESSORY CIRCUIT	
ADDITIONAL CONFIGURATIONS	10	PROTECTION.....	21
ADDRESS JUMPER.....	8	EXPANSION UNIT COMPONENTS	
ALARM		DIAGRAM.....	7
SPECIFICATIONS.....	24	EXPANSION UNIT INSTALLATION LOCATION	
ALARM CABLE REQUIREMENTS	19	DIAGRAM.....	12
ALARM CONFIGURATION		EXPANSION UNIT POWER SUPPLY	
SUPERVISED	19	REPLACING	23
ALARM CONNECTION	19	EXPANSION UNIT POWER SUPPLY FUSE	21
ALARM INPUTS	8, 19	EXPANSION UNIT PRIMARY FUSE.....	20
BACKUP BATTERY.....	5	FAULT CONDITIONS	19
BACKUP BATTERY REPLACEMENT	23	FCC WARNING.....	2
BATTERY.....	13	GENERAL DESCRIPTION.....	5
LOAD	5	GROUND BOND STRAP.....	11
BATTERY BACKUP		I/O SERIAL SIGNAL.....	8
SPECIFICATIONS.....	24	INCOMING POWER CONDUIT KNOCKOUT.....	14
BATTERY-TOP CHARGER	5	INDICATORS.....	8
CABINET MOUNTING.....	13	INSTALLATION	11
CABINET MOUNTING HOLE DIMENSIONS	13	INSTALLATION PREPARATION.....	12
CABLE		J3	9
REQUIREMENTS	6	KNOCKOUTS.....	14
CABLE AND WIRING CATEGORIES.....	14	LOGIC	
CHARGER PCB.....	5	INDICATOR.....	8
CICP1300IOBD		LOGIC POWER.....	8
INSTALLING.....	22	MAINS AC POWER	14
COMMUNICATION CABLES	14	MAINTENANCE	23
COMPONENT LAYOUT		MODULAR CABLE	
DIAGRAM.....	7	MAXIMUM LENGTH.....	10

MODULAR CABLE	7, 16	TERMINAL BLOCK	
REQUIREMENTS	16	CONNECTIONS	15
MOUNTING HOLES	13	DIAGRAM.....	15
MOUNTING SCREWS	13	TERMS OF SALE	26
OK		VARISTORS.....	18
INDICATOR.....	8	VIRTUAL INPUTS	25
PC BOARD LAYOUT.....	8, 9	WALK THROUGH TEST.....	11
PLENUM-RATED CABLING.....	14	WARRANTY	26
POWER CONNECTIONS	15	WIRING	14
POWER RATING SPECIFICATIONS	24	TAMPER SWITCH.....	19
POWER SUPPLY REPLACEMENT.....	23	WIRING DIAGRAM	31
RELAY			
CHARACTERISTICS	18		
SPECIFICATIONS.....	24		
RELAY			
INDICATOR.....	8		
RELAY CONNECTIONS	18		
RELAY CONTACT RATINGS	8		
RELAY CONTACTS	8		
RELAY OUTPUTS.....	5		
RELAY POWER.....	17		
RLY PWR OUT	9		
HEADER.....	17		
SAFETY INFORMATION.....	6		
SECOND ALARM/RELAY BOARD	10		
SECOND SUPERVISED ALARM/RELAY BOARD			
INSTALLING.....	22		
SERIAL SIGNAL	8		
SOFTWARE VERSION			
REQUIREMENTS	5		
SPECIFICATIONS	24		
STATUS LED			
SPECIFICATIONS.....	24		
SUPER TWO EXPANSION BOARD MAPPING ..	25		
SUPERVISED ALARM INPUTS.....	8		
SUPERVISED ALARMS.....	19		
SUPERVISED INPUTS.....	5		
SUPERVISION CIRCUIT.....	9		
SUPPLY VOLTAGE			
SPECIFICATIONS.....	24		
TAMPER SWITCH.....	5, 19		
SPECIFICATIONS.....	24		

NOTES

CONTINENTAL INSTRUMENTS CICP1300IOCOMBO WIRING DIAGRAM



REFER TO INSTALLATION INSTRUCTIONS W11473

LED INDICATORS-

- EVENT: CHANGE IN ALARM INPUT STATUS.
- OK: WORKING CONNECTION TO CONTROL PANEL.
- RELAY: 12 VOLT POWER TO RELAYS.
- LOGIC: 5 VOLT POWER FROM CONTROL PANEL.
- LED'S NEAR RELAY LIGHT WHEN RELAY ACTIVATED.

AC ON: (CHARGER BOARD) MAINS POWER.
12V: (CHARGER BOARD) 12 VOLT OUT OKAY.



ALARM CIRCUITS ARE POWER LIMITED
USE 2.3MM OR 3/32" SCREWDRIVER

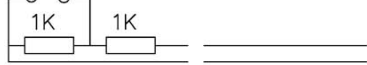

ALARM INPUTS ARE SOFTWARE CONFIGURABLE N.O. , N.C. ETC.

MAX RELAY LOAD RATING 24V AC/DC 2 AMP.
CONNECT ONLY TO POWER-LIMITED CIRCUITS.

NOTES:

- 1.) AC WIRING MUST BE IN ACCORDANCE WITH LOCAL WIRING CODES.
- 2.) AC BRANCH CIRCUIT OVERCURRENT PROTECTION DEVICE MUST BE RATED 15 AMP OR LESS.
- 3.) USE THE SAME AC BRANCH CIRCUIT TO POWER THE ACCESS CONTROL PANEL AND EXPANSION UNIT(S).
- 4.) DO NOT RUN AC WIRING THROUGH THE KNOCK-OUT WITH ANY OTHER WIRING.
- 5.) RELAY AND ACCESSORY POWER MUST USE A KNOCKOUT DIFFERENT FROM ANY OTHER WIRING.

TO SECOND ALARM/RELAY BOARD (IF USED)

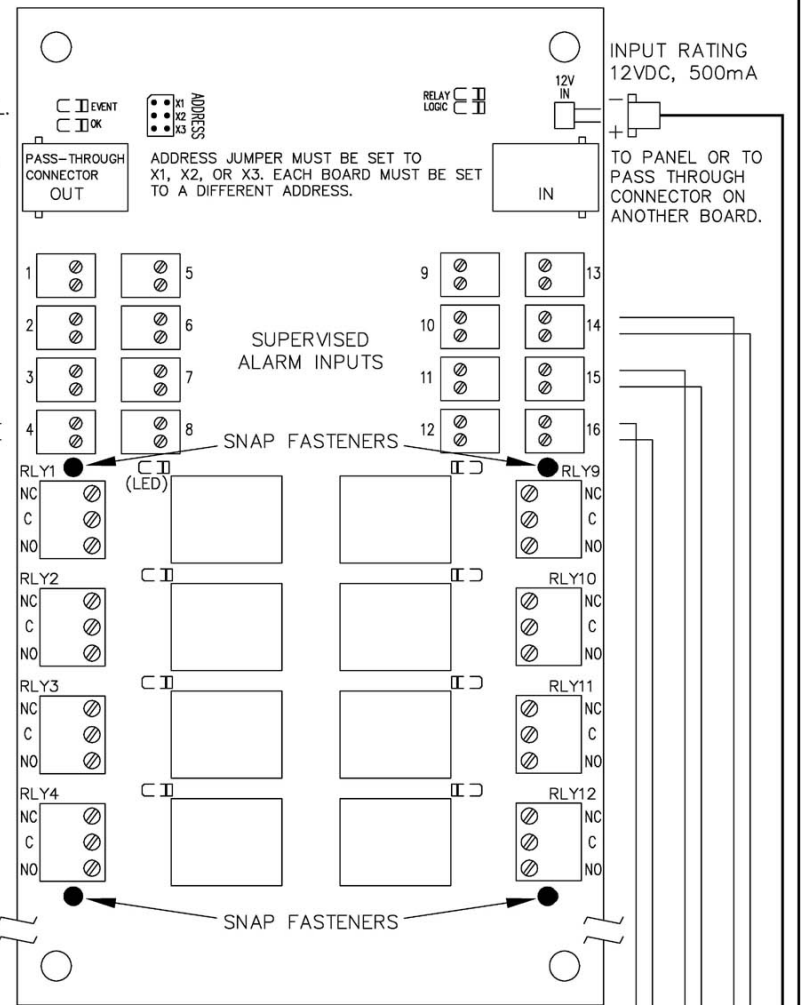

AC POWER INPUT AREA

(DO NOT ENTER THE BOXED AREA WITH FIELD WIRING)

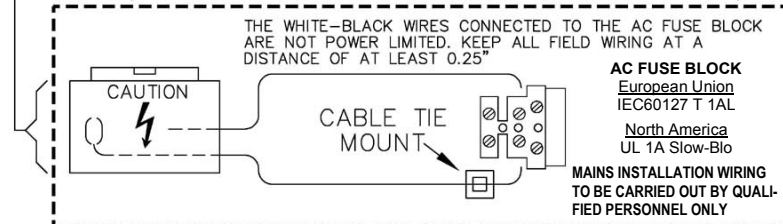

12V (LED) ACC. PWR OUT
POWER OUTPUT RATING 12VDC, 1600 mA.
POWER LIMITED.

RLY PWR OUT
RELAY POWER OUTPUT. USE THE CABLE PROVIDED.

AC OK 12V OK
AC OK IS CLOSED WHEN NORMAL. 12V OK IS CLOSED WHEN NORMAL.

OPEN COLLECTOR OUTPUTS: LOWER SIDE OF ALARM INPUT MUST CONNECT TO RIGHT SIDE OF THESE ALARM OUTPUTS.

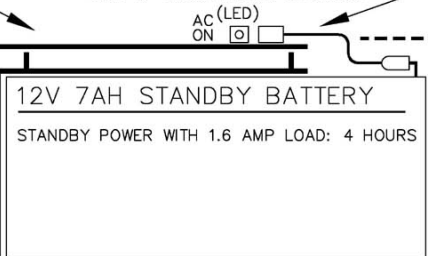

LA2408A

Continental Access 

CONTINENTAL INSTRUMENTS LLC

A NAPCO SECURITY GROUP COMPANY

355 Bayview Avenue, Amityville, NY 11701
Phone: 631-842-9400 Fax: 631-842-9135